

SERIES 1450 TERRACE OUT-SWING DOOR

TEST SIZE W x H	AAMA RATING	AIR INFILTRATION	DESIGN PRESSURE	WATER RESISTANCE	U-VALUE	SHGC	VT
48" x 96"	AW-PG75	≤0.10 cfm/ft ²	75 psf	12 psf	0.32-0.54	0.15-0.5	0.2-0.53



TABLE OF CONTENT

- INTRODUCTION -P1
- 1450 -P2
- 1450-1 -P3
- 1450-2 -P4
- MULLION -P5-P7
- ANCHOR LIP & ADA SILL -P8
- FACE FLANGE -P8-P9

FEATURES

- ALUMINUM THERMAL-BREAK TERRACE OUT-SWING DOOR
- 3-1/4" FRAME DEPTH
- 1" DOUBLE PANE INSULATED TEMPERED GLASS
- HEAVY DUTY EXTRUSION
- AAMA 2604 POWDER COAT PAINT
- OPENING LIMIT BAR
- MULTI POINT LOCK SYSTEM
- THUMB TURN INTERIOR LOCKING MECHANISM

OPTIONAL SELECTIONS

- LOW-E COATING & ARGON FILLED IGU
- 2" FACE FLANGE
- CUSTOM FINISH AND CUSTOM COLOR
- GRIDS
- 1-1/4" INSULATED GLASS
- ADA LOW SILL
- KEY LOCK ON EXTERIOR

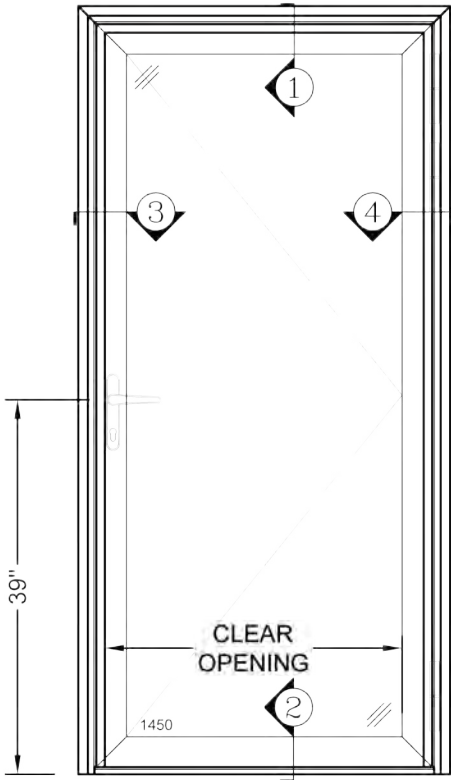

1450 OUT-SWING DOOR

(CLEAR OPENING = DOOR WIDTH - 7³/₄")

① HEAD
CTT1450

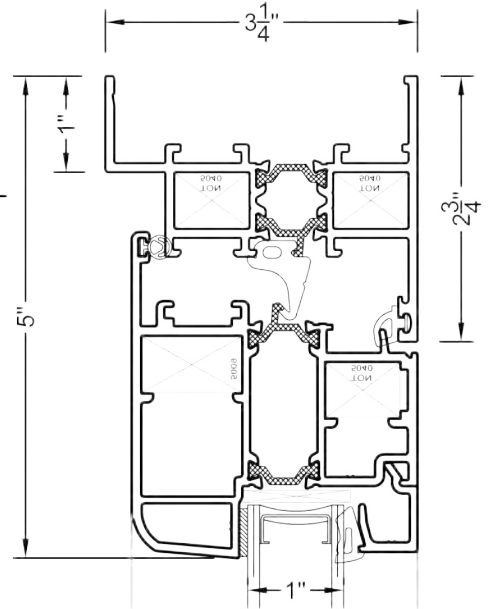

② SILL
CTT1450

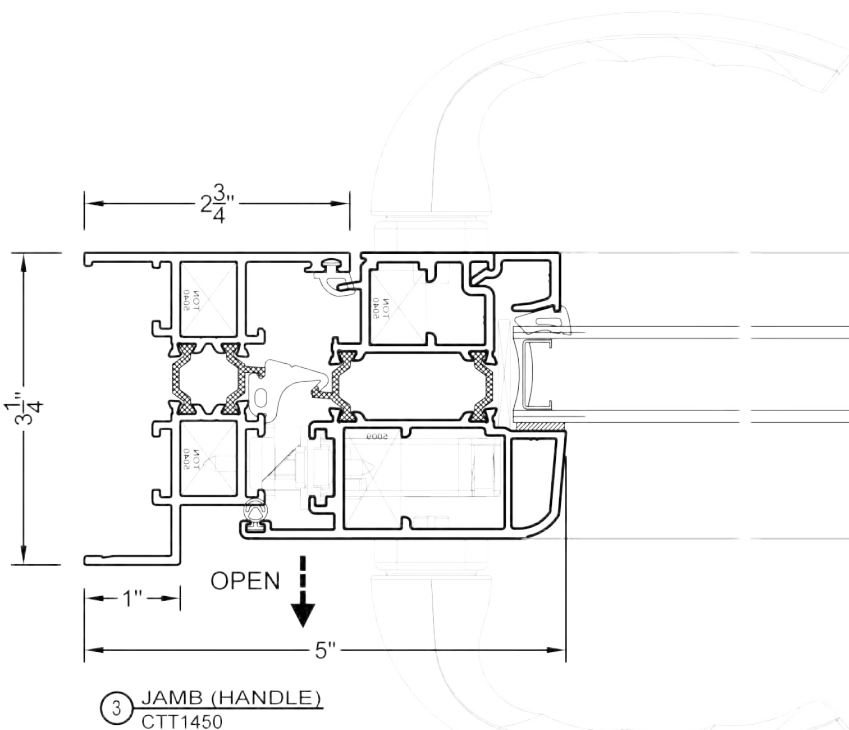
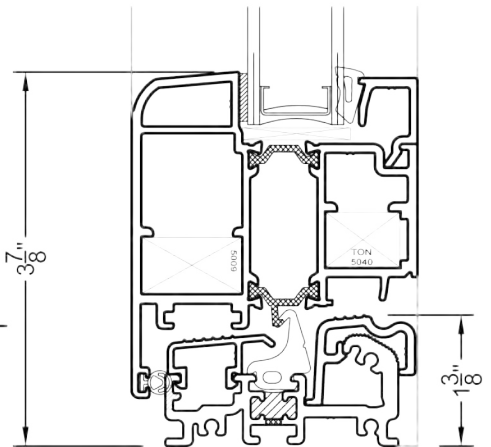

③ JAMB (HANDLE)
CTT1450

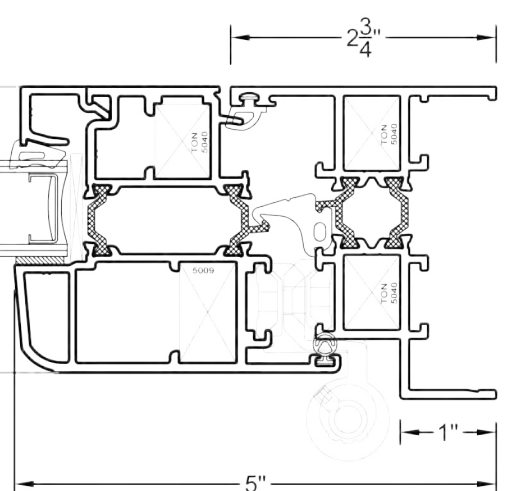

④ JAMB (HINGE)
CTT1450

VER: 2020.03

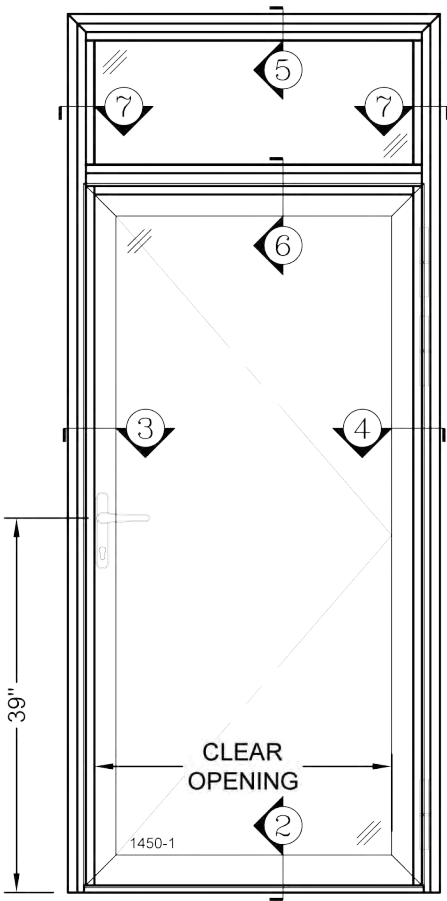

1450-1 OUT-SWING DOOR
 W/ TRANSOM

(CLEAR OPENING = DOOR WIDTH - 7 $\frac{3}{4}$ ")

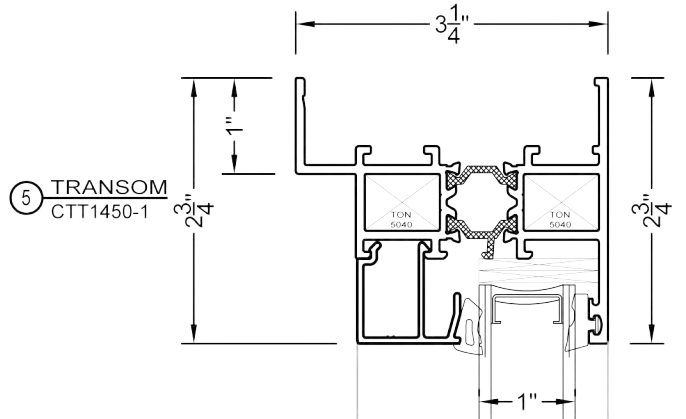

5 TRANSOM
 CTT1450-1

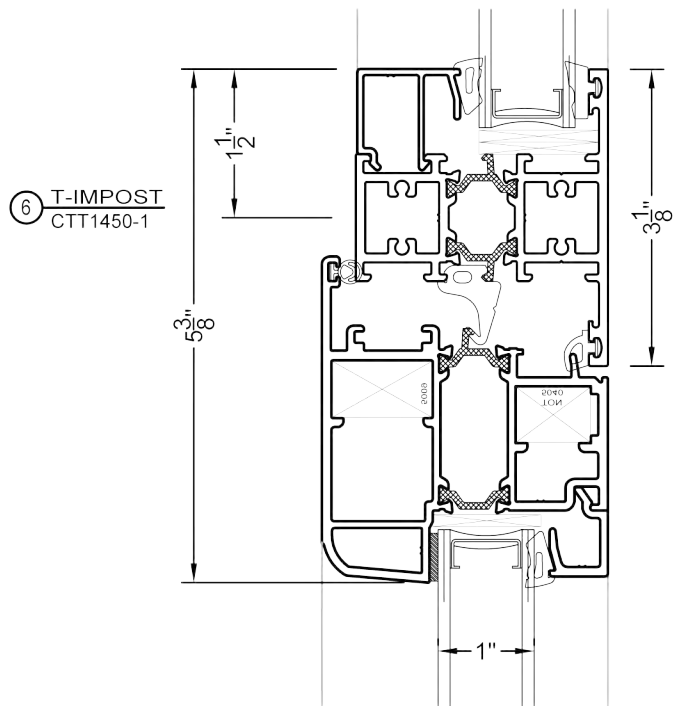

6 T-IMPOST
 CTT1450-1

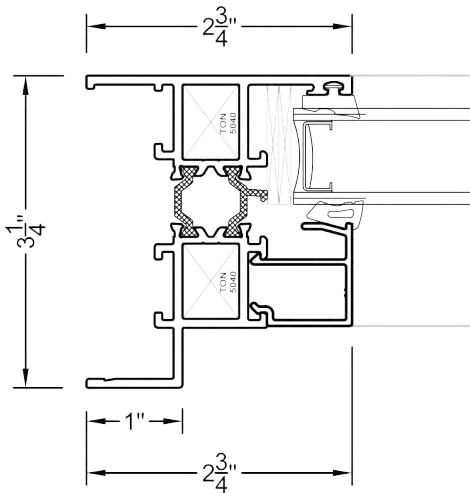

7 JAMB (TRANSOM)
 CTT1450-1

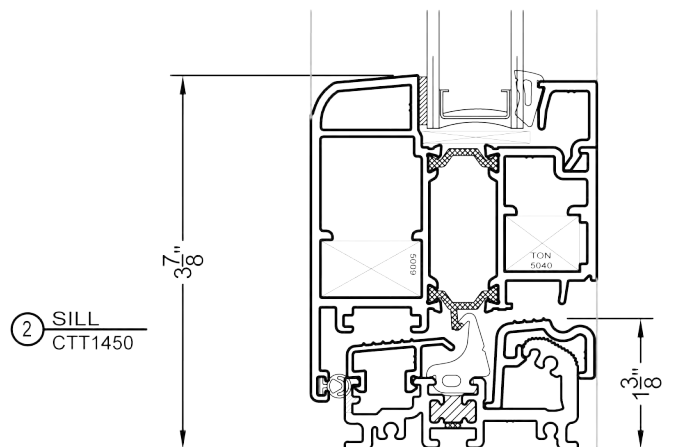

2 SILL
 CTT1450

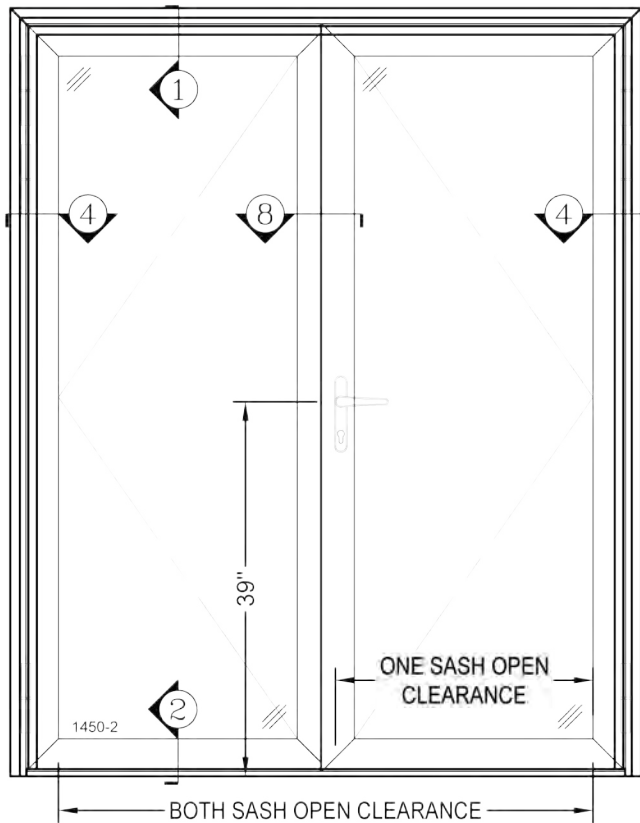

ADA SILL OR INTEGRAL TRANSOM
 IS NOT AVAILABLE FOR
 1450-2 OUT-SWING FRENCH DOOR

1450-2 OUT-SWING FRENCH DOOR*

ONE SASH OPEN:
 (CLEAR OPENING = DOOR WIDTH / 2 - 6")

BOTH SASH OPEN:
 (CLEAR OPENING = DOOR WIDTH - 10")

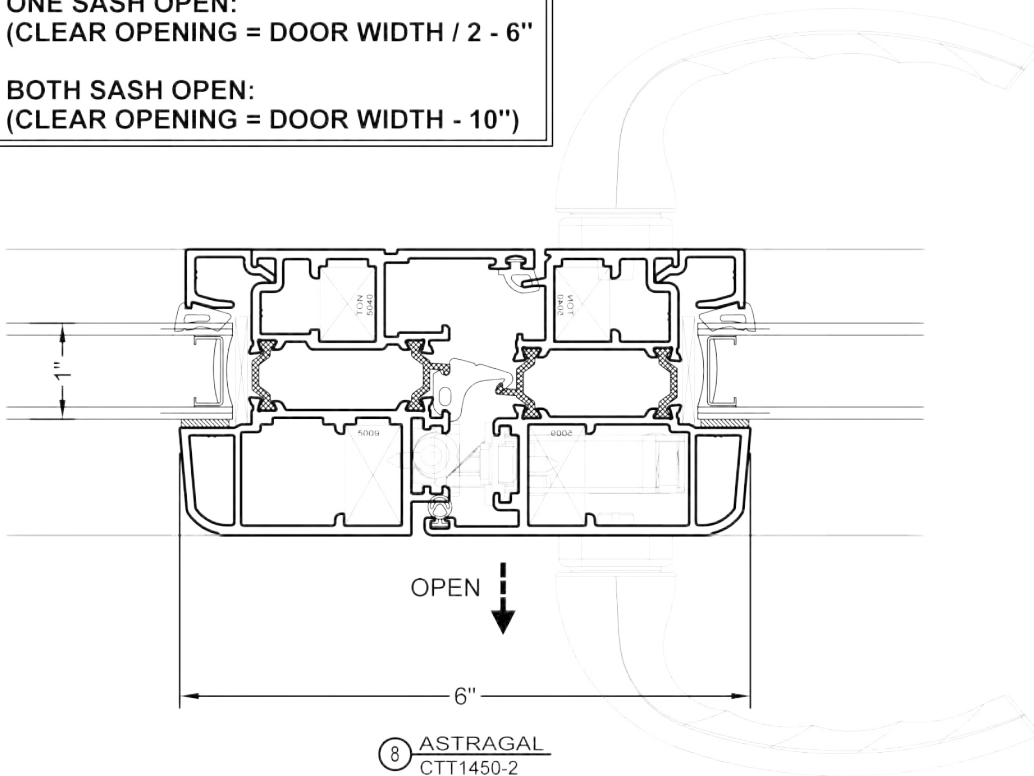

8 ASTRAGAL
 CTT1450-2

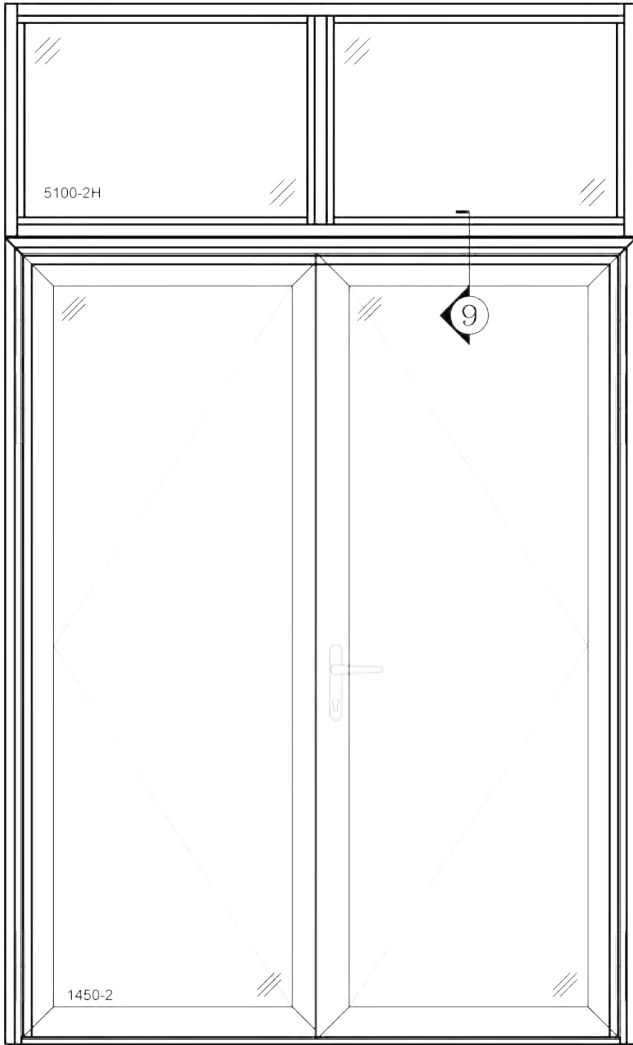

PW5100-2H TRANSOM OVER CTT1450-2
 W/ H MULLION

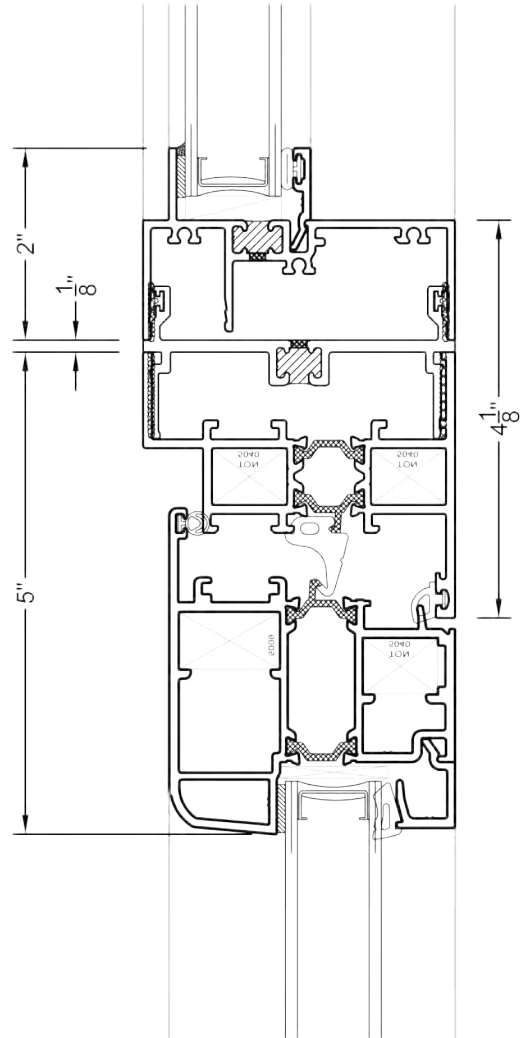

9 H MULLION
 PW5100 OVER CTT1450

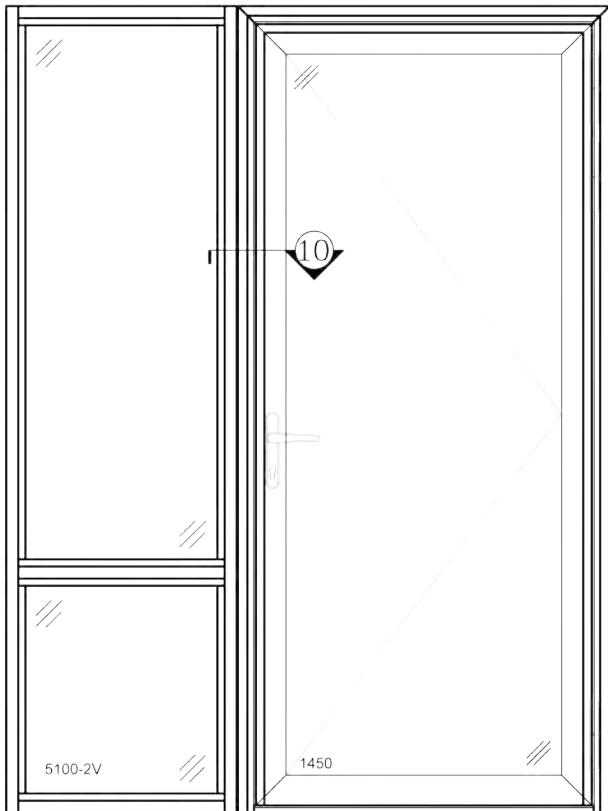

PW5100-2V SIDELITE & CTT1450
 W/ H MULLION

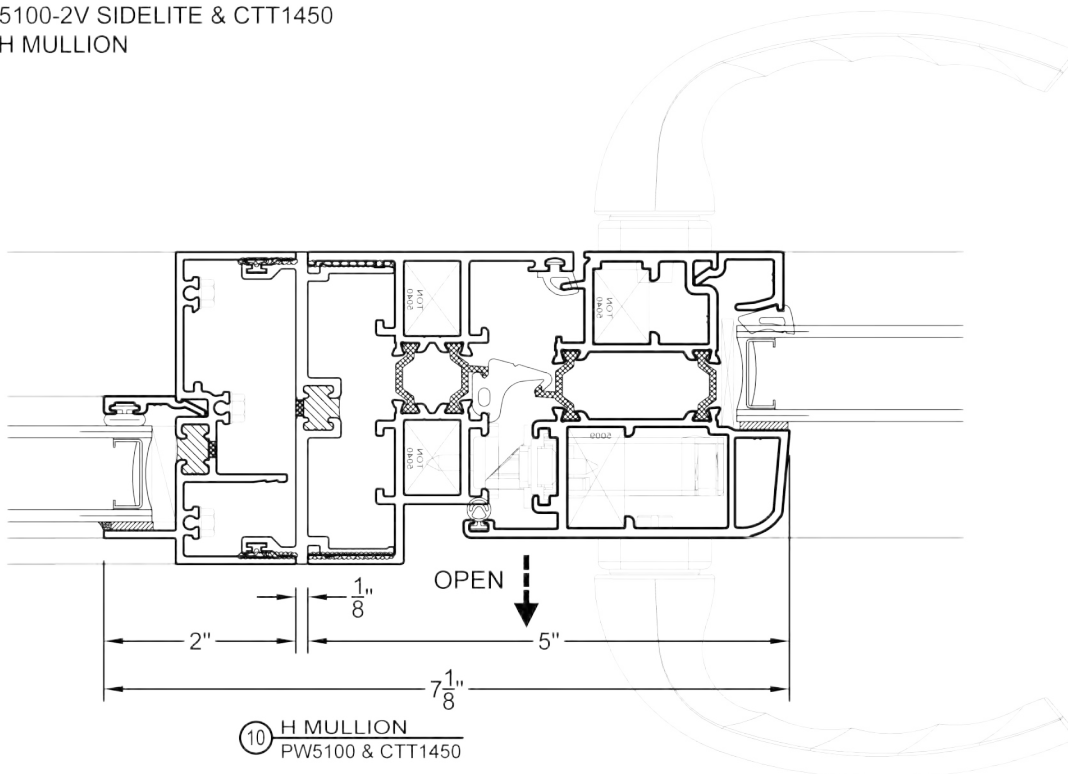

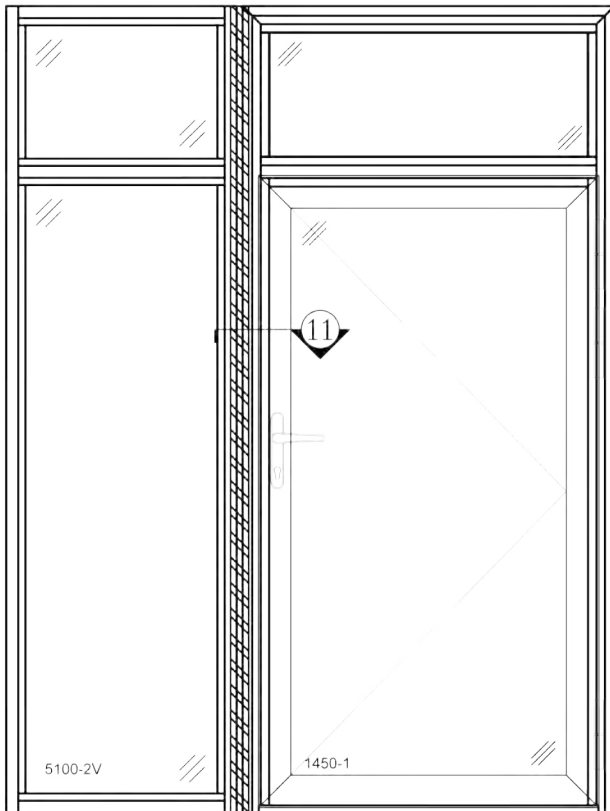

PW5100-2V SIDELITE & CTT1450-1
 W/ 3CP MULLION

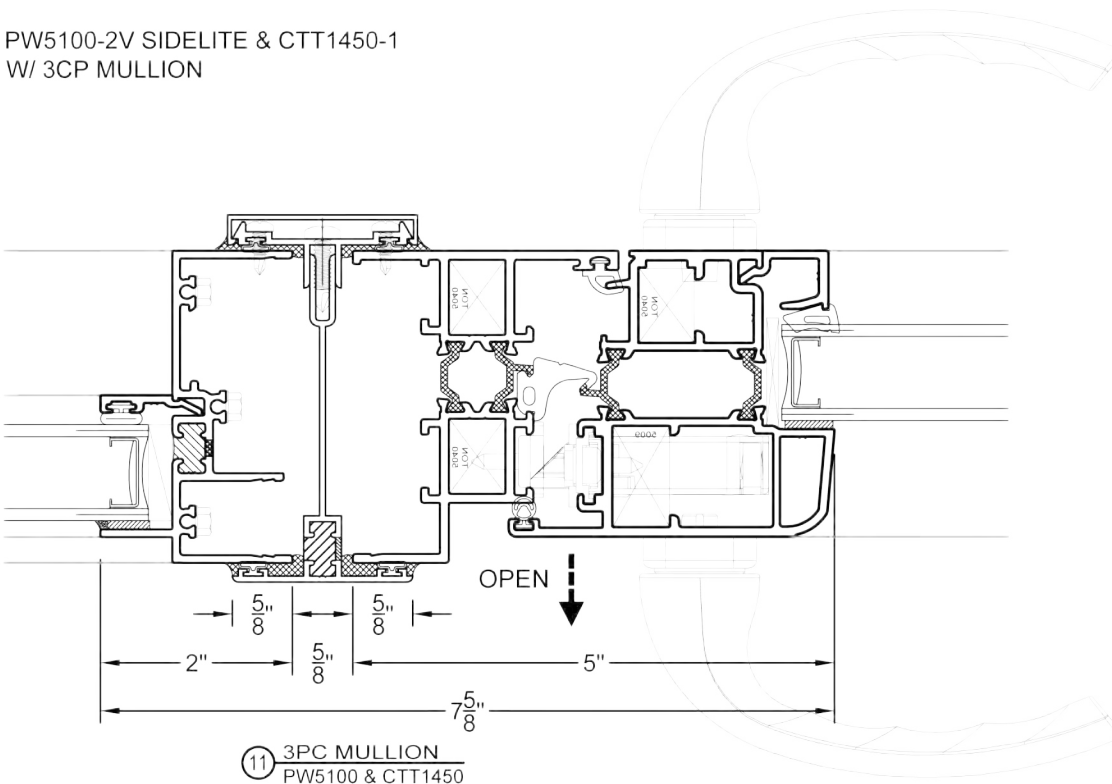

11 3PC MULLION
 PW5100 & CTT1450

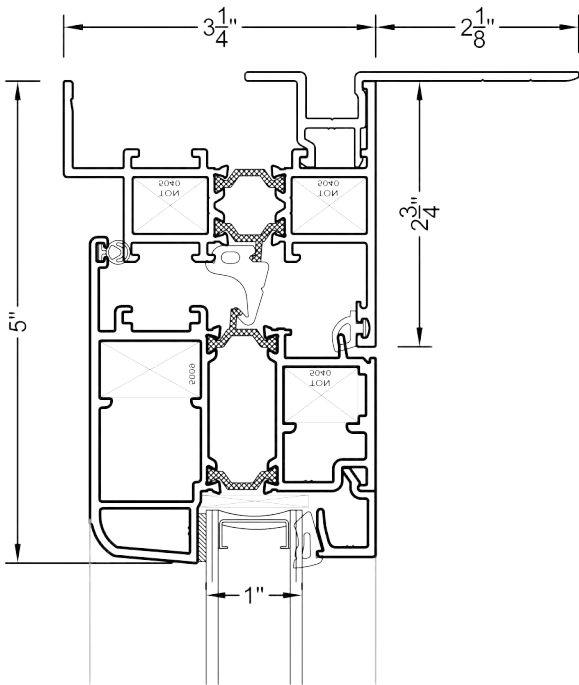

① HEAD W/ ANCHOR CLIP
 CTT1450

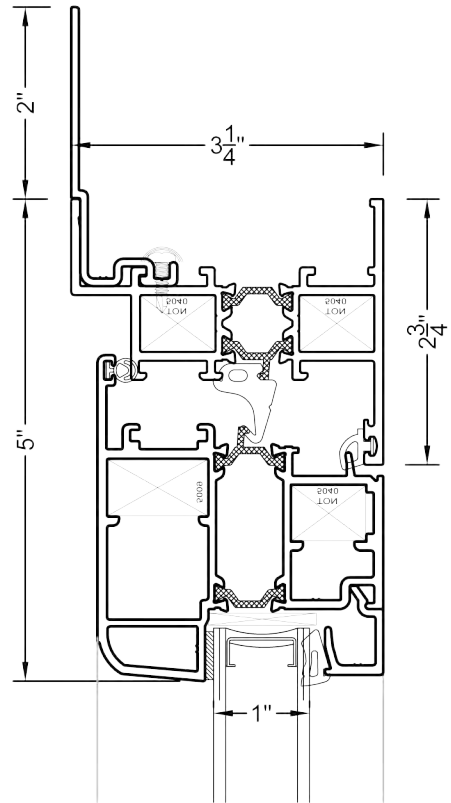

①A 2" APPLIED ON FLANGE HEAD
 CTT1450

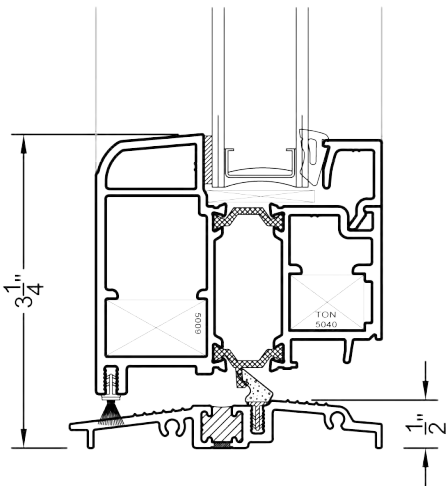

② ADA SILL
 CTT1450

WATER PERFORMANCE WARRANTY IS NOT AVAILABLE FOR ADA SILL. PLEASE CONTACT YOUR SALES REP. FOR MORE INFORMATION

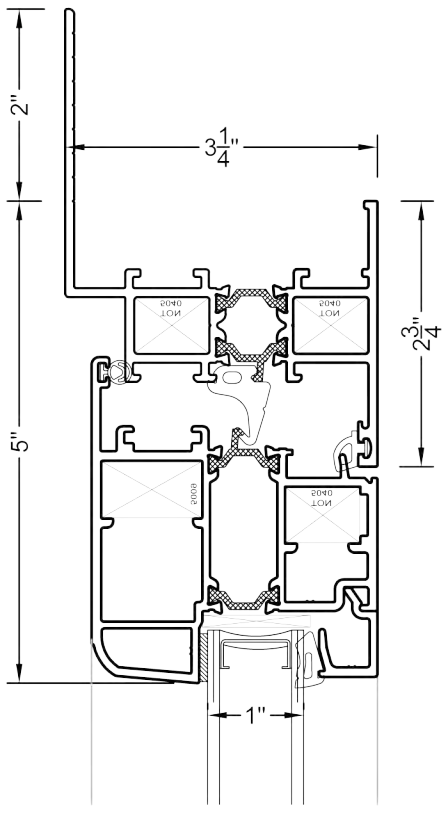

1B 2" FLANGE HEAD
 CTT1450

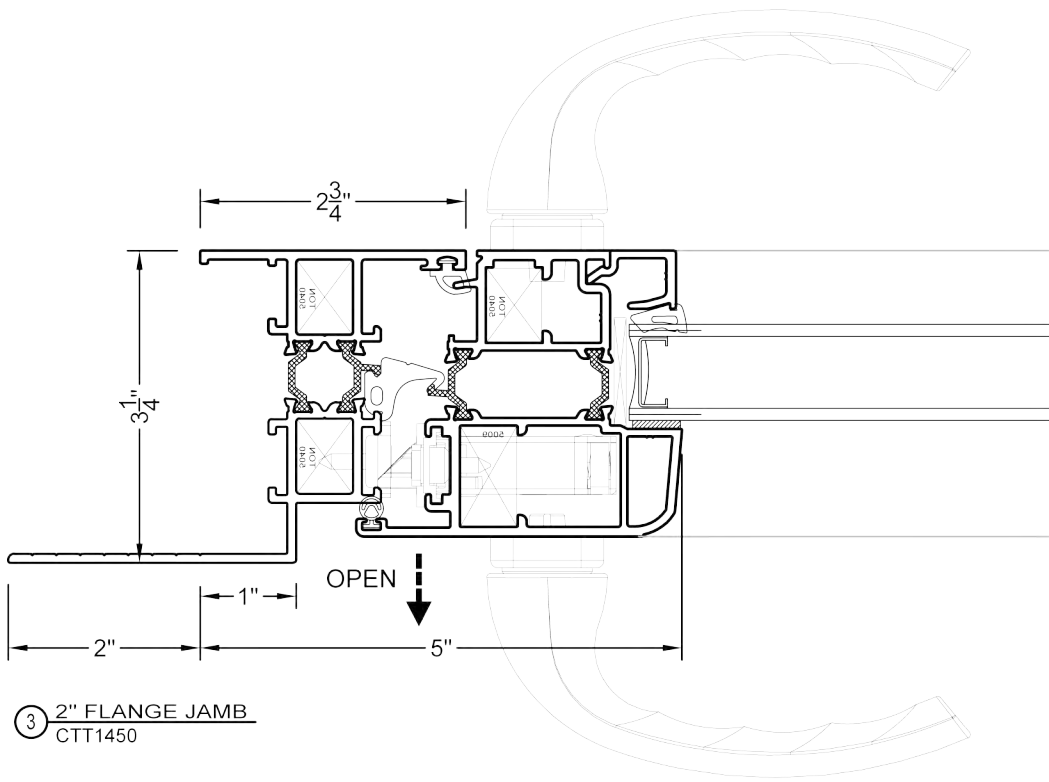

3 2" FLANGE JAMB
 CTT1450

VER: 2020.03